



Operating Instructions SCOPE-CLEANER SC10

Pump for flushing and blowing out flexible endoscopes



Document Ref.: IFU-TD03-002 Ver:0

Read the operating instructions before using the equipment for the first time.

Store the operating instructions near the device so that all users have access to the instructions at all times.

These Operating Instructions apply to the following products:

SCOPE-CLEANER SC10 flushing pump REF: 7000-S10

The SCOPE-CLEANER is a Class I / Rule 13 active medical device as defined in Annex IV of Council Regulation (EU) 2017/745. A Declaration of Conformity can be provided on request.

Standard and optional accessories

Use of the SCOPE-CLEANER SC10 in accordance with the intended purpose requires special-purpose accessories that are listed under Point 3 and in Appendix II to these Operating Instructions.

All national laws and regulations applicable in the country of use as amended from time to time must be observed and applied.



This pictograph refers to important, safety related information



CREO MEDICAL GmbH

Hans-Böckler-Straße 29
40764 Langenfeld – Germany

Tel. +49 (0) 2173 20047-0

Fax. +49 (0) 2173 20047-40

E-Mail info.de@creomedical.de

Web www.creomedical.com

Table of Contents

1	Intended purpose and patient safety	5
1.1	Contraindications	5
1.2	Important notice when using this equipment	5
1.3	Liability & disclaimer	6
2	Safety instructions	6
2.1	Authorised service technicians	6
2.2	Instruction of staff	6
2.3	Functional test	6
2.4	Hazards and risks of a general nature.....	6
2.4.1	Unauthorised opening of the device.....	6
2.4.2	Penetration of liquids	6
2.4.3	Operation in explosion-proof areas	6
2.4.4	Use of inappropriate accessories	6
2.4.5	Faulty fuses	7
2.4.6	Faulty device	7
2.4.7	Setting up the device	7
2.5	Instructions on operation.....	7
2.6	Instructions relating to cleaning agents and disinfectants	7
2.7	Instructions on using the printer.....	8
2.8	Instructions on maintenance	8
2.9	Tube connections	8
3	Standard scope of delivery	9
3.1	Components.....	9
3.2	Returning the device	9
4	Device overview	10
5	Operating the SCOPE-CLEANER SC10 flushing pump	11
5.1	Instructions for manual reprocessing	11
5.2	Connecting an endoscope	11
5.3	Rinsing with the SCOPE-CLEANER SC10.....	12
5.4	Draining off the disinfection solution.....	14
5.5	Rinsing with neutralisation fluid.....	14
5.6	Blowing out	15
6	Cleaning and disinfecting the SCOPE-CLEANER SC10 flushing pump	16
6.1	SCOPE-CLEANER.....	16
6.1.1	Place of use.....	16
6.1.2	Storage and transport.....	16
6.1.3	Preparation	16

6.1.4	Manual cleaning and disinfection	16
6.1.4.1	Equipment required	16
6.1.4.2	Procedure	16
6.1.5	Maintenance, inspection and testing	16
6.1.6	Packaging	16
6.1.7	Storage	17
6.2	Cleaning and disinfecting the tube sets	17
6.2.1	At the place of use	17
6.2.2	Storage and transport	17
6.2.3	Preparation	17
6.2.4	Pretreatment	17
6.2.5	Manual cleaning	17
6.2.6	Manual disinfection	18
6.2.7	Automated cleaning and disinfection (AER)	18
6.2.8	Maintenance, inspection and testing	19
6.2.9	Sterilising	19
6.2.9.1	Packaging	19
6.2.9.2	Sterilisation	20
6.2.10	Storage	20
6.3	Additional information	20
7	Maintenance	20
7.1	Repairs	20
7.2	Responsibilities	20
8	Troubleshooting	21
9	Final disposal	21
10	Technical specifications	22
11	EMC conditions	23
A:	Connecting Olympus endoscopes	25
B:	Connecting Fujifilm endoscopes	26
C:	Connecting Pentax endoscopes	27
D:	Connecting Huger endoscopes	28
	Appendix II: Accessories for SCOPE-CLEANER SC10	29
	Appendix III: Replacement parts for SCOPE-CLEANER SC10 flushing pump	30
	Appendix IV: Recommendations for preventing contamination through infection	31
	SERVICE LOGBOOK	32
	Reporting	33
	Certificates	33

1 Intended purpose and patient safety

The SCOPE-CLEANER SC10 flushing pump is a simple flushing pump and is used to flush and blow out medical products, especially flexible endoscopes made by various manufacturers, with liquids such as cleaning agents or disinfectants.

The SCOPE-CLEANER SC10 can be applied in a manual process with device support (flushing pump), in which cleaning and disinfection are carried out on the contaminated side and the final flush on the clean side.

The SCOPE-CLEANER SC10 device should only be operated in accordance with its intended purpose in the manner described in this manual.

The SCOPE-CLEANER SC10 can be used to rinse the following endoscopes:

- 1.) All watertight endoscopes made by
OLYMPUS, FUJIFILM, PENTAX, STORZ and HUGER

In order to guarantee your own safety and ensure the full functionality of the SCOPE-CLEANER, please make sure you read the safety instructions carefully.

1.1 Contraindications

Use the SCOPE-CLEANER SC10 flushing pump only for its intended purpose. Do not use the SCOPE-CLEANER SC10 in the following cases:

- For flushing endoscopes if no information regarding their suitability for reprocessing with the SCOPE-CLEANER SC10 is available.
- If the endoscope has more than four channels.
- If the endoscopes are to be used for examinations in zones that are not microbially colonised.

If in doubt, please contact the manufacturer of the endoscopes and Creo Medical GmbH.

1.2 Important notice when using this equipment

Read the operating instructions before using the SCOPE-CLEANER SC10 for the first time and familiarise yourself with the functions and mode of operation of the device and accessories.

Failure to comply with these operating instructions may result in injury to patients, users and maintenance personnel, and may also result in damage to the device or endoscope, or the device and endoscope may stop working completely.

The SCOPE-CLEANER SC10 must only be operated by staff that meet the requirements in terms of factual knowledge prescribed in the German regulations governing the installation, operation, use and maintenance of medical devices (MPBetreibV) and have been instructed and trained in safe use of the device.

The quality of the processing procedure is to be subjected to regular microbiological checks (MPBetreibV) Hygienic & microbiological checks are an integral component of the hygiene schedule (Sec. 36, IfSG (Law on Protection against Infection) – Infection systems)

The SCOPE-CLEANER SC10 is classified as a manual process with device support (flushing pump), in which cleaning and disinfection must be carried out on the contaminated side and the final flush on the clean side. The SCOPE-CLEANER SC10 is not a device for mechanical reprocessing in the sense of the recommendations by the Robert Koch Institute (RKI), nor is it a disinfection device in the sense of EU Directive 93/42/EEC.

1.3 Liability & disclaimer

Creo Medical GmbH is not liable for any damage, direct or consequential, which occurs under the following conditions:

- If the device or accessories are operated, reprocessed or maintained inappropriately
- If the instructions and specifications set out in these Operating Instructions are not observed
- If repairs, adjustments or modifications to the device or accessories have been carried out by unauthorised persons
- If the device has been opened by unauthorised persons
- If the prescribed inspection and maintenance intervals are not observed.

2 Safety instructions

2.1 Authorised service technicians

Only service technicians certified by Creo Medical GmbH are authorised to carry out repairs, adjustments or modifications to the device and accessories. Authorised service technicians are trained and certified exclusively by Creo Medical GmbH.

2.2 Instruction of staff

On-site training is provided by Creo Medical GmbH or a person authorised by us.

2.3 Functional test

Before using the SCOPE-CLEANER SC10, check the equipment to ensure all components are in place and that the device is working properly. Before using the device for the first time and after repairs have been carried out, always check that the equipment has been installed properly. The manner of operation is explained in Chapter 5 under 'Operating the SC10 SCOPE-CLEANER'.

2.4 Hazards and risks of a general nature



In the event there is serious risk of danger, disconnect the device from the power supply immediately (pull out the plug).

Then call the service technician to remedy the fault and recommission the device.

2.4.1 Unauthorised opening of the device

Live components become exposed when the device is open and can cause electric shocks if touched. Never open the device yourself. The device may only be opened by an authorised Creo Medical GmbH service technician.

2.4.2 Penetration of liquids

Liquid entering the device may prevent the device from working properly and/or present the risk of electric shock. Fluids should therefore never be permitted to enter the device. Always avoid placing fluids in the vicinity of the electrical components.

Do not operate if liquid has penetrated the device.

2.4.3 Operation in explosion-proof areas

The device is not explosion-proof. Operation in areas with explosive gases can lead to severe damage and cause serious injury.

2.4.4 Use of inappropriate accessories

The use of inappropriate accessories can cause the device to operate incorrectly, which may result in injury to patients, users, third parties and service technicians. Use only accessories specified for operation with the SCOPE-CLEANER SC10 (refer to Appendix II).

2.4.5 Faulty fuses

When replacing a faulty fuse, please ensure the new fuse corresponds with the specifications displayed on the device or set out in these Operating Instructions.

The use of the wrong fuses can cause the device to function incorrectly and may result in injury to users and others.

2.4.6 Faulty device

It is generally dangerous to operate a faulty device. Do not operate the device if you suspect it to be faulty or if it is known to be faulty. Make sure the device cannot be operated until checked by an authorised technician.

2.4.7 Setting up the device

When installing the device, ensure the ambient conditions listed below are complied with.

- Use in closed rooms
- Degree of contamination 2 (minor, normal contamination that may become conductive due to occasional dew formation or hand-transmitted sweat).
- The device must never be used in explosive atmospheres.
- 10° C to 35° C ambient temperature
- Air humidity max. 70%
- Operation up to an altitude of 2.000 metres (metres above sea level)
- This device must be installed and operated in accordance with the electromagnetic compatibility (EMC) instructions contained in this manual.
- Portable and mobile high-frequency (HF) communication equipment (e.g. mobile phones) may affect the way the device functions.
- The device may not be used stacked together with or beside other devices.

2.5 Instructions on operation

Only endoscopes which have been properly checked for leaks in accordance with their manufacturer's instructions may be flushed with the SCOPE-CLEANER SC10.

If a leakage tester is used, observe both the instructions issued by the manufacturer of the endoscope and those issued by the manufacturer of the leakage tester when performing the leakage test. The testing requirements are contained in the appropriate Operating Instructions.

Appendix I shows how various endoscope models are connected to the SCOPE-CLEANER SC10.

When reprocessing flexible endoscopes, observe the general requirements relating to handling endoscopes that are applicable to endoscopy wards.

- 'Hygiene requirements when reprocessing medical equipment.'
- Hygiene requirements when processing flexible endoscopes and additional instruments used in endoscopy.
- 'Hygiene requirements as applied to the design and construction of endoscopy instruments in endoscopy units'.
- Organic substances
- Regulations relating to suppliers of medical products

2.6 Instructions relating to cleaning agents and disinfectants

Please refer to the operating instructions supplied with your endoscope for information on cleaning agents and disinfectants which are compatible and approved for use with endoscopes.

If you intend to use a cleaning agent or disinfectant which is not expressly recommended for use by the endoscope manufacturer, please obtain written evidence of compatibility from either the endoscope producer or the disinfectant manufacturer. Instructions issued by the manufacturer of the endoscope on material compatibility must be followed exactly.

When disinfecting endoscopes, use only disinfectants whose germicidal, fungicidal, mycogermicidal and virucidal effectiveness have been verified. Disinfectants certified to be in accordance with DIN EN standards for disinfecting medical implements and/or in accordance with the standard methods published by DGHM/VAH are considered to be suitable. Efficacy in destroying viruses must be separately demonstrated. Observe the recommendations issued by RKI on the testing and declaring the effectiveness of disinfectants in combating viruses.

Observe the instructions issued by the manufacturers of the chemicals and endoscopes (e.g. regarding effective range of application, concentrations to be used).

The disinfectant should be changed according to the manufacturer's instructions or sooner if there is visible contamination.

2.7 Instructions on using the printer

Suitable printers are available from Creo Medical GmbH as optional accessories.

The printer has its own power supply.

In order to ensure proper functioning of the printer, it must not be switched on until after the SCOPE-CLEANER SC10. has been started.

There are pictographs in the paper compartment of the printer to explain how to insert paper. Only use paper that is suitable for use with this printer. Further details are available in Appendix II.

2.8 Instructions on maintenance

The prescribed regular services are essential to ensure that this device works correctly. If these regular services are not performed, the warranty on the parts to be serviced will lapse. Our prescribed maintenance interval is 12 months.

2.9 Tube connections

Both the tubes inside the device and the connection tubes must be replaced once a year.

3 Standard scope of delivery

Check the device and accessories immediately upon delivery to ensure all components are included and look for any visible external damage.

3.1 Components

- 1.) SCOPE-CLEANER SC10
Spare part no. 7000-S10



- 2.) Shrouded mains cable with earthed plug
Spare part no.



- 3.) Set of tubes
Spare part no. 7501-NS0 FUJIFILM and OLYMPUS
Spare part no. 7501-NS1 PENTAX
Spare part no. 7501-NS2 HUGER



- 4.) Operating Instructions



Operating Instructions
SCOPE-CLEANER SC10

Pump for flushing and blowing out flexible endoscopes



CE

10/2016 01 11 2016 Rev 1

3.2 Returning the device

If you need to return the device, please use the original packaging. We will not accept responsibility for damage incurred during transport as a result of inappropriate packaging.

4 Device overview

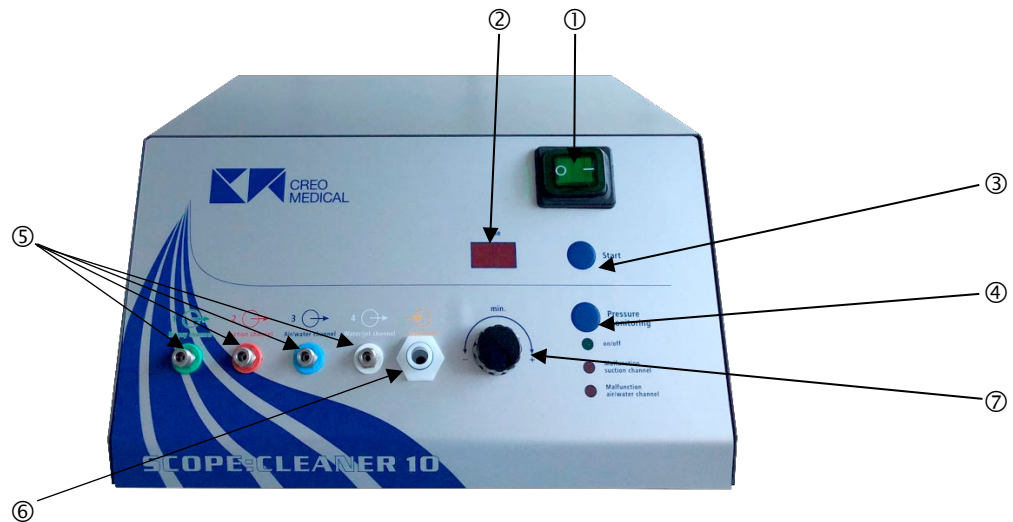

Fig. 01 Overview of the device, front



Fig. 02 Overview of the device, rear

- ① **Mains switch:** (OFF) 0 - (ON) 1
- ② **Display** (total and residual time)
- ③ **Button** for starting the flushing process
- ④ **Button** for switching channel monitoring ON and OFF
- ⑤ **CPC coupling** for attaching the suction tube
- ⑥ **Luer lock** for attaching the pressure tubes
- ⑦ **Timer selector** 0-60 minutes
- ⑧ **Opening** for adjusting pressure monitors
- ⑨ **Port for connecting** log printer
- ⑩ **Shrouded 3-pin plug:** Only connect the device to a power supply conforming with the details given on the rating plate

5 Operating the SCOPE-CLEANER SC10 flushing pump

5.1 Instructions for manual reprocessing

Use of manual disinfection systems assumes the following conditions are adhered to:

- The device is used in accordance with the written standard instructions applicable to manual disinfection processes
- All the cleaning and agents and disinfectants used, as well as the processes used to apply them, must be suitable and material-compatible (in line with their manufacturers' instructions)
- Implementation must be validated.

If reprocessing is done manually, the Operator must demonstrate in writing that both subprocesses, i.e. cleaning and disinfection, are performed to an equivalent standard. Evidence of the equivalence of the method must be demonstrated by the following criteria:

- Comprehensive instructions from the manufacturer regarding manual disinfection in accordance with DIN ISO EN 17664.
- Use of a CE certified implement disinfection solution with a suitable range of applicability
- Objective evidence by the Operator of the effectiveness of the disinfection process, in the case of medical devices classified in risk class 'semicritical B'.

Any work involving contact with disinfection solutions as defined in the biological substances regulations (German enactment of EU Directive 2000/54/EC) must take account of all personal protection measures. Protective clothing must always be worn when performing the procedures described below. Because the air in the reprocessing room may contain a high level of disinfectant fumes, there must be adequate ventilation or air extraction.

- Robert Koch Institute: Hygiene requirements when processing flexible endoscopes and additional instruments used in endoscopy.
- Employees' safety organisations: Organic substances
- Regulations on the use of medical equipment
- Only use cleaning and disinfecting agents approved by the endoscope manufacturer.
- If you use different cleaning agents or disinfectants, you must check that they are compatible before you use them.
- Clean the endoscope in accordance with the instructions provided by the manufacturer of the endoscope before it is flushed with cleaning agent or disinfectant, i.e. all channels must be free of any blockages.

5.2 Connecting an endoscope

1. Attach the biopsy channel tube (green), which is connected to the biopsy channel adapter for the biopsy channel, to the left-hand Luer lock connection ('Biopsy channel', green)
2. Attach the suction channel tube (red), which is fitted to the suction port of the endoscope, to the middle Luer lock connection ('Suction channel', red)
3. Connect the air/flush channel tube (blue) to the air channel on the endoscope body (for Olympus and Fuji) and twist to the right-hand Luer lock connection ('Air/water

channel', blue). Close off the suction and air/water valve and, if the device is an Olympus CF device, also close off the water bottle port and CO2 gas port.

4. Connect the jet channel tube (white) to the jet channel connection on the endoscope and twist to the right-hand Luer lock connection ('Water/jet channel', white).

Your endoscope is now connected and ready for flushing with liquid (cleaning agent or disinfectant).

Bronchoscopes (not cystoscopes) can also be flushed with the SCOPE-CLEANER SC10 by connecting the existing channels as described above using suitable adapters. Please put any unused tubes connected to the SCOPE-CLEANER SC10 into the reprocessing tray. Under no circumstances should unused outlets of the SCOPE-CLEANER SC10 be closed off.



Please remember:

Before using disinfectant, blow out any remaining residues of cleaning fluid from the endoscope channels to prevent the disinfectant becoming diluted.

5.3 Rinsing with the SCOPE-CLEANER SC10

Check that the mains electricity supply is correctly connected.

Set the mains switch ① to ON (I).

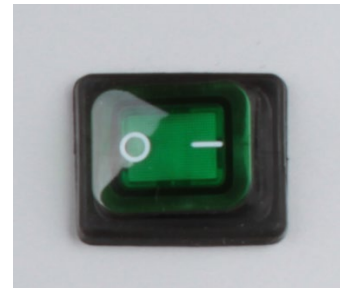

Switch ON channel monitoring ④ 'Pressure monitoring'.
Press 'Pressure monitoring', when 'AUTO' is selected, the green ON/OFF LED will light up.

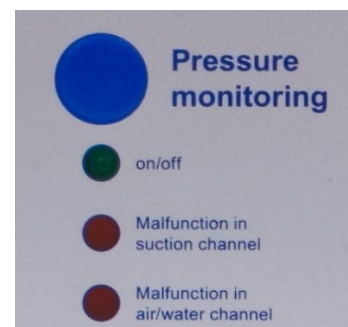

Set timer⑦ to the required disinfection time.
(Depending on the disinfection solution and its concentration).
The display will show the total running time

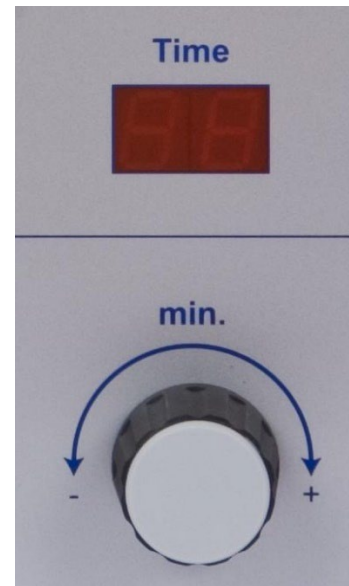

Press ③ 'START'.
The suction tube draws in disinfection solution via 4 channel pumps and this is forced through the endoscope.
The air escapes via the distal tip of the endoscope, i.e. all the channels are free.
No air bubbles must escape from other places, e.g. on the handle or from the connection tubes.
If you see bubbles, set the mains switch to 'OFF'(0) and check the endoscope.

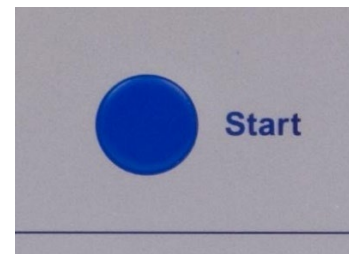

When the flushing process with disinfection solution has completed, an acoustic signal is heard.



If, despite thorough precleaning, a channel is still blocked, i.e. if the malfunction indicator for the Air/water or Suction channel does not automatically disappear:

Follow the instructions in this order:

1. Set the mains switch to '0' (OFF).



All the tubes are filled with disinfection solution and the blocked tube is under pressure.

2. Pinch the tube just behind the endoscope connection and remove the tube carefully.
3. Insert the tube in the disinfection solution and gradually let go.
4. Do the same to the other tubes.
5. Now clear the blockage e.g. with the cleaning brush.

5.4 Draining off the disinfection solution

After the flushing period has expired, remove the suction tube from the disinfection solution.

Set the timer to 3 minutes, press 'START'.

The pumps will suck in air and, after a brief delay, there will be air bubbles at the distal tip.

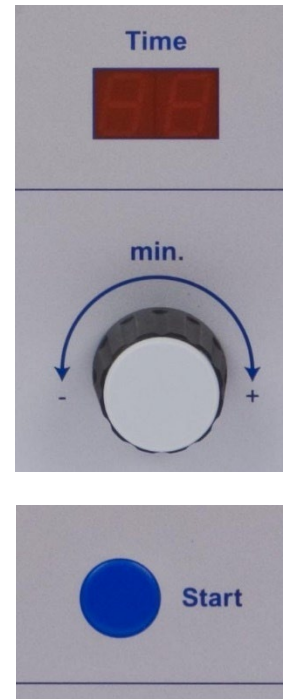

5.5 Rinsing with neutralisation fluid

Place the endoscope in the water-filled tank.

Place the suction tube in the tank and set the timer to 5 minutes, press 'START'.

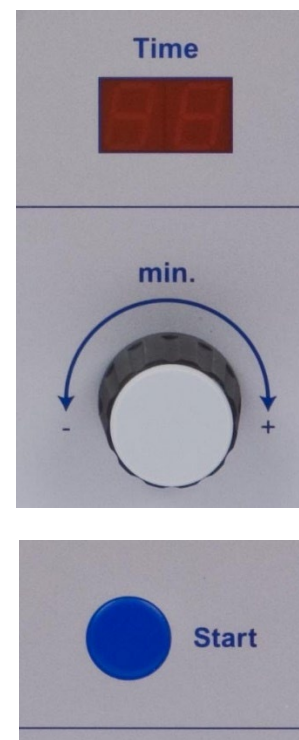

5.6 Blowing out

Remove the endoscope from the tank.

Set the timer to 5-10 minutes (depending on the effective length of the endoscope), press 'START'.

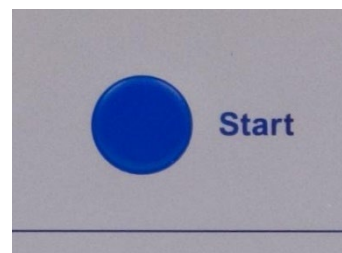
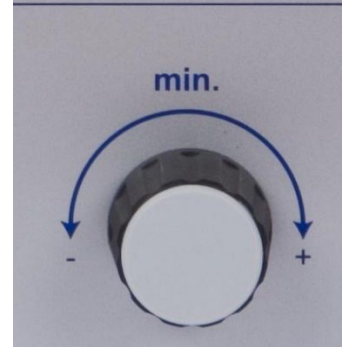
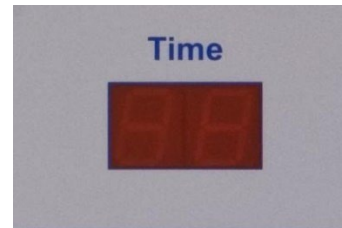

Switch off the device, set the mains switch to 'OFF (0)'.



Because the control head contains cavities (depending on the model) there may be residual fluid in the suction and air/water valve.

Hold the control head in such a way that the valves are facing down, then remove the valve plugs and lightly shake the control head.

Refit the suction and air/water valve.

6 Cleaning and disinfecting the SCOPE-CLEANER SC10 flushing pump

If the SCOPE-CLEANER SC10 has not been used for more than 24 hours, or if no disinfectant was used during the last operation (e.g. flushing only with enzyme cleaner), self-disinfection must be carried out by pumping disinfectant through the SCOPE-CLEANER SC10 for the duration specified by the manufacturer of the disinfectant. The connecting hoses must remain attached to the SCOPE-CLEANER SC10, and the free ends must be in the tray.

Only validated processes may be used for the reprocessing of medical devices.

6.1 SCOPE-CLEANER

6.1.1 Place of use

Unplug the device and remove the accessories used (e.g. set of tubes, blowgun)

6.1.2 Storage and transport

When transported outside the room in a closed container.

We recommend reprocessing medical devices as soon as possible, at the latest within 2 hours of use.

6.1.3 Preparation

Wear personal protective equipment (solid gloves, water-repellent protective coat, face mask or goggles and mask).

6.1.4 Manual cleaning and disinfection

6.1.4.1 Equipment required

Non-protein-fixing VAH-listed (VAH = Association for Applied Hygiene) instrument disinfectant based on quaternary compounds, acetals and aldehydes (e.g. Beta Guard RFU wipes, Dr Deppe GmbH)

6.1.4.2 Procedure

- 1) Take a disinfection wipe and wipe the surfaces of the device thoroughly.
- 2) Ensure that all surfaces, grooves and indentations in the device are wiped and thoroughly moistened during the cleaning process.
- 3) To clean the ventilation grille, wipe it thoroughly on the outside, then fold the disinfection wipe and clean all the gaps between the individual louvres.
- 4) Check the areas for cleanliness and, if contamination is still visible, repeat the above steps.
- 5) To disinfect the surfaces, take a further disinfection wipe and wipe the surfaces of the device thoroughly.
- 6) Ensure that all surfaces, grooves and indentations in the device are wiped and thoroughly moistened during the disinfection process.
- 7) To disinfect the ventilation grille, wipe it thoroughly on the outside, then fold the disinfection wipe and clean all the gaps between the individual louvres.
- 8) Allow the disinfectant to soak in for the time specified by the disinfectant manufacturer (e.g. Beta Guard RFU wipes require five minutes).
- 9) Allow the device to dry off.

6.1.5 Maintenance, inspection and testing

We recommend annual maintenance of such devices by Creo Medical GmbH or a person authorised by us.

6.1.6 Packaging

No special requirements.

6.1.7 Storage

Store the device in a dust-protected, cool, dark and dry place, the storage time must be in accordance with the specifications of the user.

6.2 Cleaning and disinfecting the tube sets



Note

Special attention is required when cleaning lumened instruments. Machine cleaning and disinfection require a special load carrier with cavity flushing, e.g. load carrier for microinvasive instruments (MIC trolleys). The configuration of these load carriers varies depending on the manufacturer. The cleaning performance depends on the configuration and adaptability of the instrumentation on the load carrier and must be verified by validation of the processes.

Suitable disinfection solutions for reprocessing are aldehydic and peracetic acid solutions.

If correctly handled without contamination of the adapters and tubes, the tube set should be reprocessed every four weeks.

6.2.1 At the place of use

Depending on the set of tubes: Disconnect the sterile gas strainer from the tubes.

6.2.2 Storage and transport

It is recommended to transport the contaminated tube sets in a closed container.

6.2.3 Preparation

Wear personal protective equipment (solid gloves, water-repellent protective coat, face mask or goggles and mask).

6.2.4 Pretreatment

Equipment required: mains water / running water (20 ± 2 °C, at least drinking water quality), 20 ml syringe (e.g. B. Braun #4606205V), tub for mains water.

- 1) Place the tube system in a tub of water (at least drinking water quality) for at least five minutes. Fill the lumens of the tubes with water using a 20 ml syringe and ensure the tubes are free of air bubbles.
- 2) Remove the tubing system from the water and remove any residue from the lumen using an air-filled 20 ml syringe.

6.2.5 Manual cleaning

Note: Carry out manual pretreatment before subjecting the tube system to full manual cleaning (see Pretreatment).

Equipment required: multi-stage enzymatic cleaner (InstruZym, by Dr Deppe GmbH, #600001) mains water / running water (20 ± 2 °C, at least drinking water quality), cleaning brush (the following have been validated: Interlock #26024, brush head diameter: 2.5 mm, brush head length: 15 mm, overall length: 2.300 mm, Interlock #26090, brush head diameter: 2.5 mm, brush head length: 15 mm, overall length: 2.300 mm), 20 ml syringe (e.g. B. Braun #4606205V), tub for mains water.

- 3) Prepare the cleaning solution according to the manufacturer's instructions (e.g. InstruZym 3%, temperature between 35 °C and 45 °C).
- 4) Carry out all further cleaning steps with the items fully immersed in the liquid to prevent splashing of contaminated liquid.
- 5) Immerse the tube set completely in the cleaning solution.

- 6) Brush the hard-to-reach areas where it is not possible to assess the cleaning effect visually with a soft cleaning brush.
- 7) Then brush the lumens of the tubing system by pushing the brush completely through the lumen and then pull the brush through at the end of the tubes. Remove contaminations from the brush head. Repeat the step once more.
- 8) Fill the lumens of the tubes with cleaning solution using a 20 ml syringe and ensure the tubes are free of air bubbles.
- 9) Allow a total exposure time in the cleaning solution of at least five minutes (a period of five minutes has been validated).
- 10) Remove the tube system from the cleaning solution and remove any residues of cleaning solution from the lumens using an air-filled 20 ml syringe.
- 11) Place the tube system in a tub of water (at least drinking water quality) for at least one minute (a period of one minute has been validated). Rinse the lumens with a 20 ml syringe at least once to remove the residue of the cleaning solution completely.

Check the tube set for cleanliness and, if contamination is still visible, repeat the above manual cleaning steps.

6.2.6 Manual disinfection

Equipment required: non-protein-fixing VAH-listed (VAH = Association for Applied Hygiene) instrument disinfectant based on quaternary compounds, acetals and aldehydes (e.g. InstruPlus viruguard, Dr Deppe GmbH #600052) preferably demineralised water (deionised water, according to KRINKO / BfArM recommendation free of facultatively pathogenic microorganisms), 20 ml syringes (e.g. B. Braun #4606205V), tub for disinfectant, tub for deionised water, lint-free cloth, medical-grade compressed air (in accordance with the European Pharmacopoeia).

- 1) Prepare the disinfectant solution according to the manufacturer's instructions (InstruPlus viruguard 5%).
- 2) Immerse the tube set completely in the disinfection solution.
- 3) Fill the lumens of the tubes with disinfection solution using a 20 ml syringe and ensure the tubes are free of air bubbles.
- 4) The soak phase in the disinfectant solution according to the manufacturer of the disinfectant (InstruPlus viruguard 5%): 15 minutes)
- 5) Remove the tube system from the disinfection solution and remove any residues of disinfection solution from the lumens using an air-filled syringe.
- 6) Place the tube set in a tub of deionised water for at least one minute. Rinse the lumens with a 20 ml syringe at least once to remove any residues of the disinfection solution completely.
- 7) Wipe with a lint-free disposable cloth and dry the lumens with medical-grade compressed air.

6.2.7 Automated cleaning and disinfection (AER)

Note: Carry out manual pretreatment before subjecting the tube system to full automated cleaning (see Pretreatment).

Equipment required: automated endoscope reprocessor (AER) according to DIN EN ISO 15883-1+2 with a thermal programme (temperature 90 °C to 95 °C), mild alkaline cleaner (LabomatMA , Dr Deppe GmbH #600032), neutralising (LabomatKS, Dr Deppe GmbH #600021), medical-grade compressed air (according to European Pharmacopoeia).

- 1) Place the tube set in a suitable mesh basket or place it on the load carrier in such a way that all the inner and outer surfaces of the tubes can be cleaned and disinfected.
- 2) The tube set must be connected to the load carrier (e.g. MIC trolley) or to a manifold (manifolds have been validated) for rinsing by means of adapters in order to flush the inner lumens. Check that the adapters are firmly attached before starting the device and at the end of the process.

- 3) Close the AER and start the programme, refer to the table below for the programme sequence:

Prog. step	Water	Dosage	Time	Temperature
Prerinse	Cold water		5 min.	
Dosage for cleaner		According to manufacturer		According to manufacturer
Cleaning	Demin. water		10 min.	55 °C
Dosage for Rinse aid		According to manufacturer		According to manufacturer
Rinsing	Demin. water		2 min.	
Disinfecting	Demin. water		3 min.	A0 value >3000 ¹ (e.g. 90 °C, 5 min.)
Drying			15 min.	Up to 121 °C
¹ Within the range of their authorisation, local authorities may adopt other rules (parameters for effective disinfection).				

- 4) At the end of the programme, remove the tube set.
- 5) Check that the set is dry and, if necessary, dry using medical-grade compressed air
- 6) After removal from the AER, the items must be examined by means of a visual inspection to ensure they are clean. If contamination is still visible, clean the tube set manually. After this manual cleaning operation, the tubes must then be reprocessed again in an automated process.

6.2.8 Maintenance, inspection and testing

- 1) The tube set must be visually checked for cleanliness, intactness and operability, if necessary by means of an illuminated magnifier (3 - 6 dioptries).
- 2) Then check the tube set for function, damage and wear.

Note: Never use products with kinks, cracks, holes or similar impairments.

6.2.9 Sterilising

6.2.9.1 Packaging

Equipment required: film-and-paper packaging (the following have been validated: steriCLIN, art. no. 3FKFS230112 and 3FKFS230114), sealing device (HAWO, type 880 DC-V has been validated).

- 1) A suitable method (sterile barrier system) must be used to pack the tube set. Packaging according to DIN EN ISO 11607 (single) or DIN 58953-9 (sets).

Individually: a sterile barrier system (foil-and-paper packaging has been validated) according to DIN EN ISO 11607 must be used, which has been approved by the manufacturer for steam sterilisation. Tube sets can be packaged singly or in pairs. The packaging must be large enough to ensure that the sealing seam is not under tension (validation involved double packaging, in foil-and-paper packaging).

Note: after heat-sealing, check visually that the sealing seam does not have any defects. In the event of any defects, the packaging must be opened and the tubing set repacked and resealed.

6.2.9.2 Sterilisation

Equipment required: steriliser according to DIN EN 285 or small steam steriliser according to DIN 13060, type B method.

Method: steam sterilization with fractionated prevacuum, 134 °C, exposure time at least 3 minutes, or 132 °C exposure time at least 3 minutes (longer exposure times are possible) (134 °C, 3 min. has been validated).

- 1) Place the packaged tube set in the sterilisation chamber.
- 2) Run the programme.
- 3) At the end of the programme, remove the tube set and allow to cool.
- 4) Then check the packaging for any damage. Packaging that is impaired in any way must be treated as non-sterile. Those instruments must be repackaged and sterilised.

6.2.10 Storage

Storage (at least protected against dust and moisture) and storage duration must be according to the user's specifications.

6.3 Additional information

Only validated processes may be used for the reprocessing of medical devices.

7 Maintenance

We recommend annual servicing of the SCOPE-CLEANER SC10 by Creo Medical GmbH or individuals authorised by us.

Diaphragms and internal tubing must be replaced at the latest once a year during scheduled servicing.

7.1 Repairs

Repairs to faulty units may only be carried out by individuals authorised by us and using only original Creo Medical GmbH spare parts.

The power cable may only be replaced with the original cable, part no. 5020-010.

7.2 Responsibilities

As Manufacturer of this device, we accept responsibility for the safety, reliability and performance of the device under the following conditions only:

- Extensions, resetting, modifications and repairs may only be carried out by individuals authorised by Creo Medical GmbH.
- The electrical installations in the room in which it is used must meet VDE requirements and the corresponding device must be used in accordance with the Operating Instructions.

8 Troubleshooting

Problem	Possible cause	Remedy
Pressure switch trips, corresponding LED 'Malfunction in suction channel' or 'Malfunction in air/water channel' lights up.	That endoscope channel is blocked.	<ol style="list-style-type: none"> 1. Set the mains switch to '0' (OFF). 2. Pinch the tube just behind the endoscope connection and remove the tube carefully. All the tubes are filled with fluid and the blocked tube is under pressure. 3. Insert the tube in the disinfection solution and gradually let go. 4. Do the same to the other tubes. 5. Now clear the blockage e.g. with the cleaning brush.
Pumps are not working. Lamp in the power switch is not lit.	Power supply outage. Faulty fuse	Check mains cable and wall socket. Check fuses at rear of device and replace if necessary.
Pumps are running but with poor performance	Suction tubes or pressure tubes are kinked. Suction filter is clogged.	Remove kink, ensure unhindered flow. Replace filter, spare part no. 7500-220
Pressure monitor switches too early or not at all	Pressure switch incorrectly set	There are two openings in the rear panel for adjusting the pressure monitors. A small screwdriver can be used to make very fine adjustments to the left or right to influence the switching point of the pressure monitors. Pressure monitor does not switch: turn the screw to the right (clockwise). Pressure monitor switches too early: turn the screw to the left (anticlockwise).
<p>If the fault cannot be remedied by simple measures, please return the device to the Manufacturer for repair.</p>		

The manufacturer is only responsible for the technical and safety-relevant characteristics of the device if all the installation, expansions, readjustments, modifications and repairs have been carried out by qualified persons authorised by the manufacturer and the electrical installation of the room meets the requirements of VDE provisions and the device has been used in accordance with the Operating Instructions.

9 Final disposal

At the end of its useful service life, the SCOPE-CLEANER SC10 and its accessories have to be disposed of in accordance with applicable local regulations as medical equipment.

10 Technical specifications

Mains supply, nominal	230 V
Primary mains voltage	230 V
Secondary mains voltage	230 V
Mains frequency	50 Hz
Wattage	87 VA
Max. power consumption	0.34 A
Primary circuit breaker	2 x T 0.25 A fine fuse (5 x 20)
Input / mains lead	Shrouded 3-pin plug
Protection class	I
Ingress protection	IP 21, for use in rooms
Operating conditions ambient temperature	10° C to 35° C
Operating conditions relative humidity	max. 70%
Overvoltage category	II
Altitude in metres	2,000 metres above sea level
Degree of contamination of the environment	2
Dimensions (height / breadth / depth)	150 x 280 x 270 mm
Weight	5 kg
Electrical safety	Complies with EN 61010-1
EMC	Complies with EN 61326-1
Flow rate	approx. 500 to 600 ml/min.

 The CE marking certifies that the product complies with EU Council Regulation 2017/745 for medical devices.

11 EMC conditions

In accordance with EN 61326-1:2013

- Radiated interference Group 1 Class B (Section 7.2)
- Electromagnetic noise immunity: To Table 2

Testing requirements for radio-frequency interference of equipment intended for use in an industrial electromagnetic environment				
Connection	Interference factor	Electromagnetic Compatibility Directive Basic standard	Test value	Evaluation criterion
Housing	Discharge of static electricity (ESD)	IEC 61000-4-2	4 kV contact discharge 8 kV air discharge	B B
		IEC 61000-4-3	10 V/m (80 MHz to 1 GHz) 3 V/m (1.4 GHz to 2 GHz) 1 V/m (2.0 GHz to 2.7 GHz)	A A A
	Mains-frequency magnetic fields	IEC 61000-4-8	30 A/m (50 Hz, 60 Hz) ^e	A
		AC power supply connection (including protective earth conductor connection)	Voltage dip	IEC 61000-4-11
Brief interruption	Fast transients	IEC 61000-4-11	0% for 250/300 cycles ^g	C
		IEC 61000-4-4	2 kV (5/50 ns, 5 kHz)	B
		IEC 61000-4-5	1 kV ^a / 2 kV ^b	B
		IEC 61000-4-6	3 kV ^f (150 kHz to 80 MHz) ^{N1)}	A
		DC supply connection ^f (including protective earth conductor connection)	Fast transients	IEC 61000-4-4
Surge voltage	Conducted HF signals	IEC 61000-4-5	1 kV ^a / 2 kV ^b	B
		IEC 61000-4-6	3 kV ^f (150 kHz to 80 MHz) ^{N1)}	A
Input/output connection (including functional earth connection)	Fast transients	IEC 61000-4-4	2 kV (5/50 ns, 5 kHz)	B
		IEC 61000-4-5	1 kV ^a / 2 kV ^b	B
		IEC 61000-4-6	3 kV ^f (150 kHz to 80 MHz) ^{N1)}	A
Input/output connector with direct connection to the power supply network	Fast transients	IEC 61000-4-4	2 kV (5/50 ns, 5 kHz)	B
		IEC 61000-4-5	1 kV ^a / 2 kV ^b	B
		IEC 61000-4-6	3 kV ^f (150 kHz to 80 MHz) ^{N1)}	A

^a Symmetrical: conductor to conductor.

^b Conductor to PE (earth).

^c Only for long cables (see 3.10).

^d Only for cables longer than > 3 m.

^e Only for magnetically sensitive devices. Interference on cathode ray tube screens may occur at field strengths above 1 A/m.

^f DC voltage connections between parts of equipment or systems not connected to a DC voltage network are treated as input/output connections.

^g For example, '25/30 cycles' means '25 cycles for 50 Hz mains frequency tests' or '30 cycles for 60 Hz mains frequency tests'.

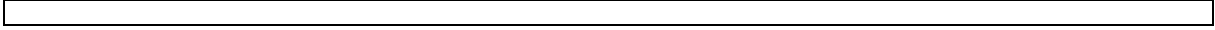

Appendix I: Connecting an endoscope

A: Connecting Olympus endoscopes

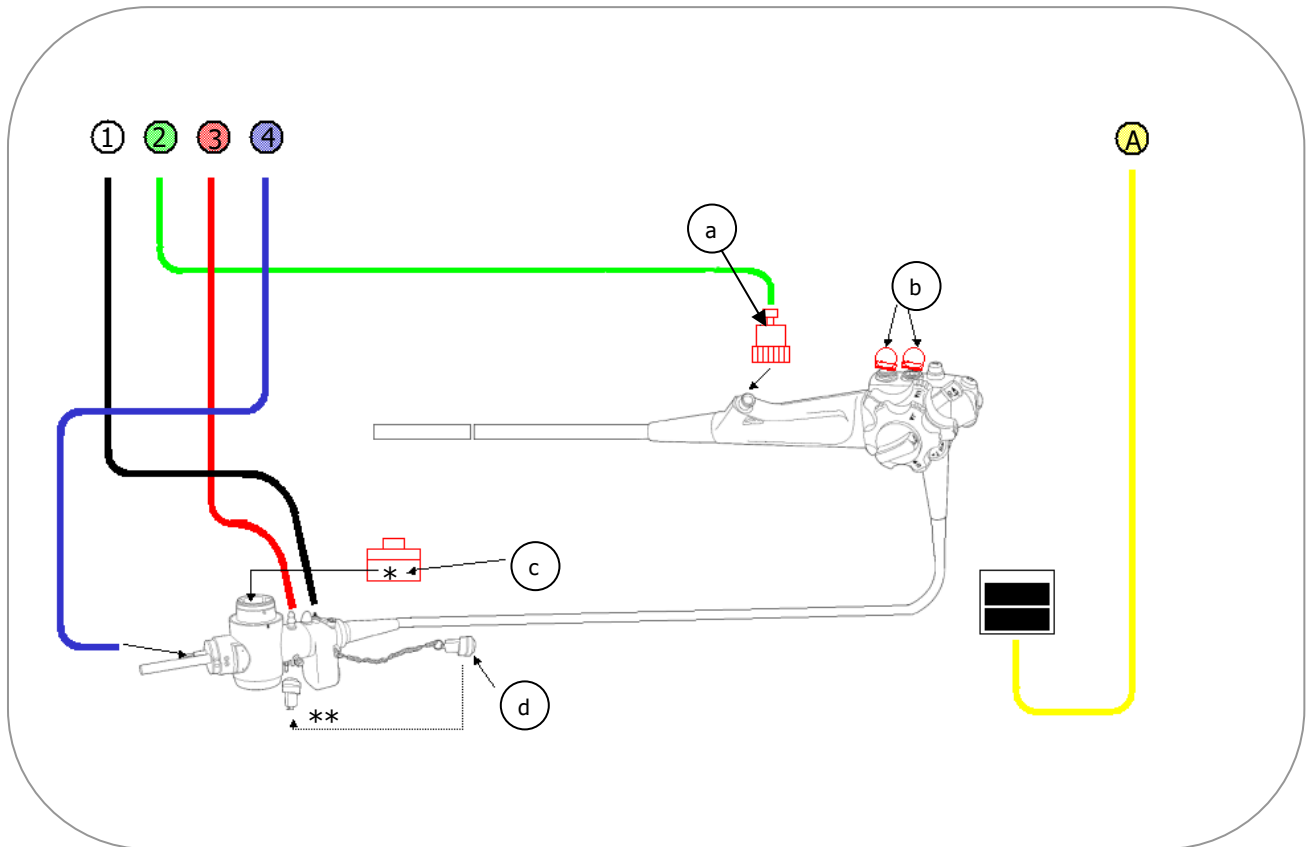

Number	Channel / designation
1	Jet channel
2	Biopsy channel in connection with caps 7524-A00
3	Suction channel
4	Air/water channel
A	SCOPE-CLEANER SC10 inlet port
a	Biopsy channel caps 7524-A00
b	Air/water channel caps 7523-000
c	Electronics cap Olympus MH-553
d	Water protective cap Olympus MAJ-583

**Water protective cap Olympus MAJ-583 must be connected to water bottle connection.

B: Connecting Fujifilm endoscopes

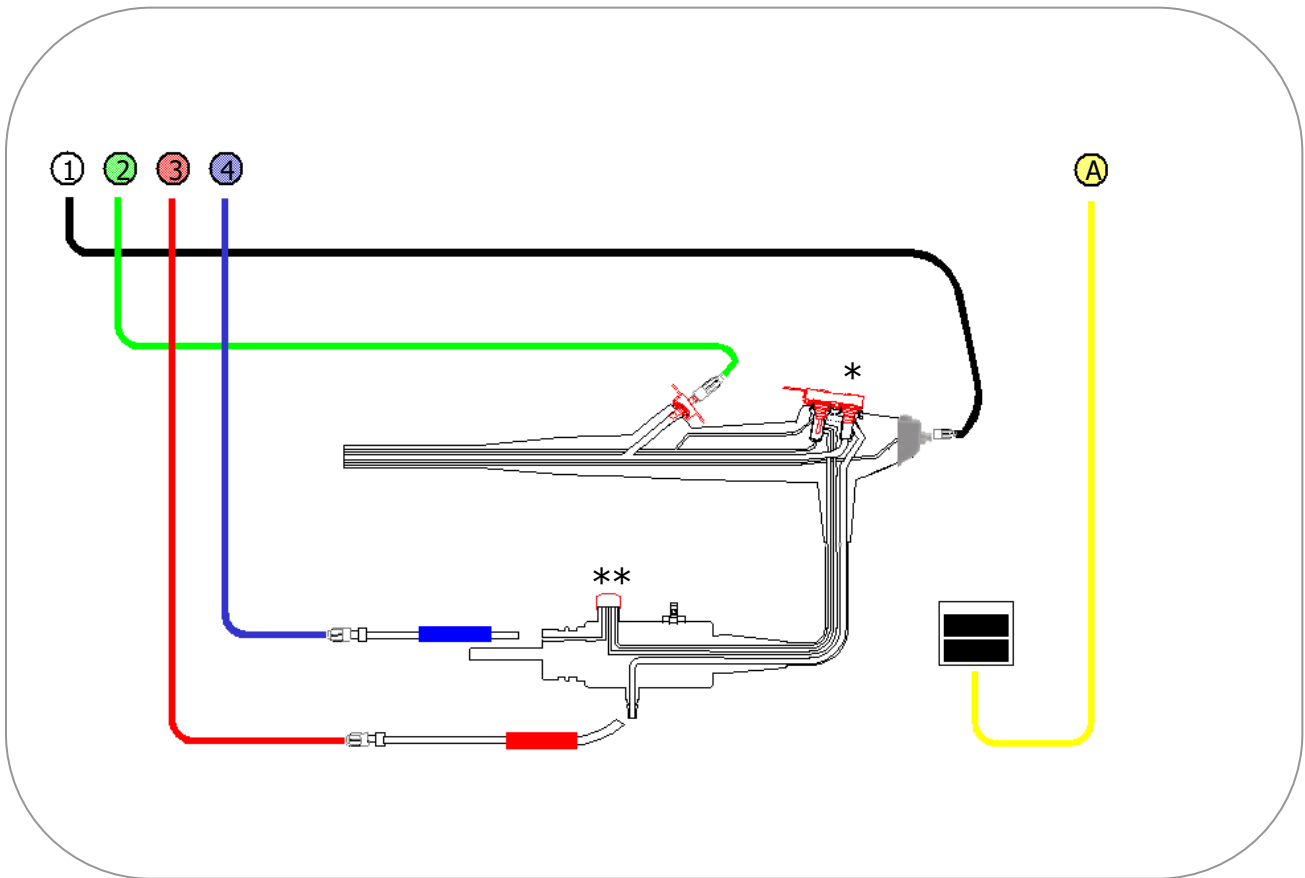

Number	Channel / designation
1	Jet channel
2	Biopsy channel
3	Suction channel
4	Air/water channel
A	SCOPE-CLEANER SC10 inlet port

*Fujifilm adapter CA-503 S/A Luer lock connections must be closed off with caps. (Refer to illustration)

** Fujifilm water bottle connection must be closed off.

C: Connecting Pentax endoscopes

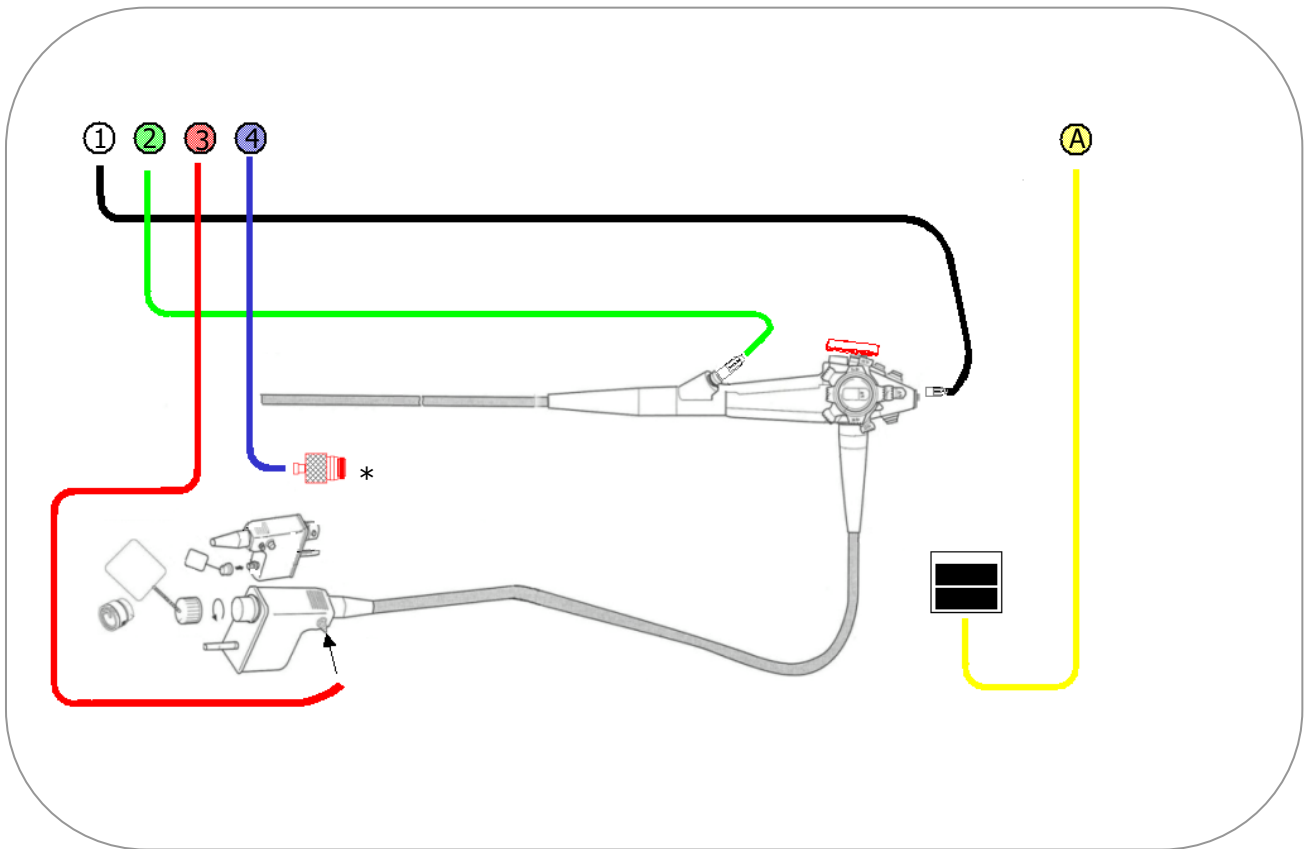

Number	Channel / designation
1	Jet channel
2	Biopsy channel
3	Suction channel
4	Air/water channel
A	SCOPE-CLEANER SC10 inlet port

*7521-100 adapter for models with individual connections for air/water channel

D: Connecting Huger endoscopes

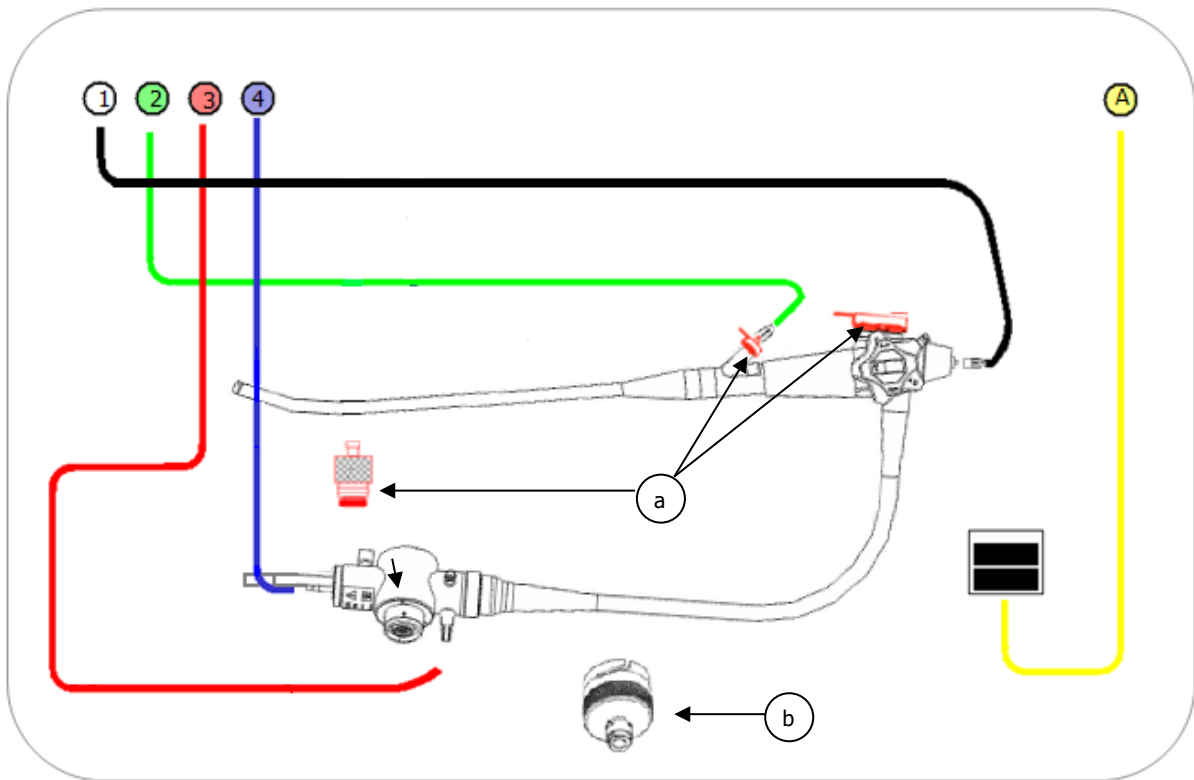

Number	Channel / designation
1	Jet channel
2	Biopsy channel
3	Suction channel
4	Air/water channel
A	SCOPE-CLEANER SC10 inlet port
a	Set for manual reprocessing *
b	Electronics cap

*SET-DIS set for manual reprocessing

Appendix II: Accessories for SCOPE-CLEANER SC10

Materials	
The connection tubes are made of silicone (Rhodosil). The Luer lock connections are made of polyamide or stainless steel	
Order no.	Description
7501-NS0	SC connection set with nylon LL suitable for Fuji/ Olympus endoscopes
7501-NS1	SC connection set with nylon LL suitable for Pentax endoscopes
7501-NS2	SC connection set with nylon LL suitable for HUGER endoscopes
7500-A10	Suction tube 1.3 m with strainer for SCOPE-CLEANER SC10 series

Connection tube for bronchoscopes

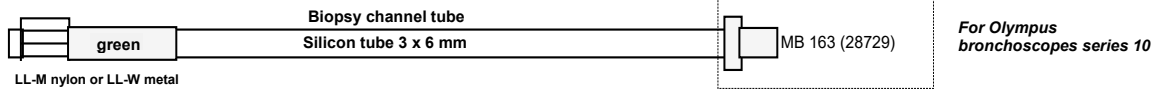
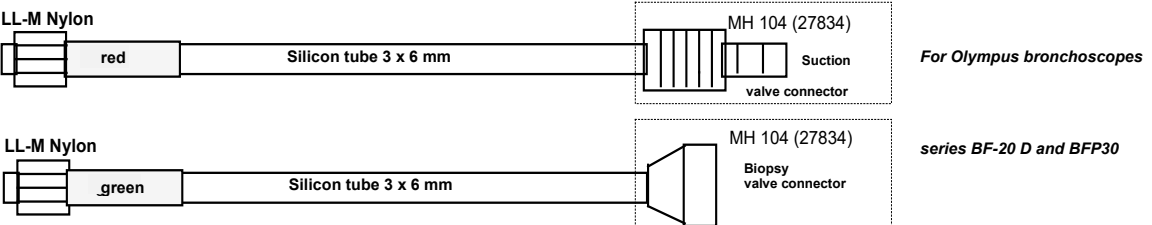
Order no.	Description	Length
7527-N00	For BC / SC with LL-W nylon connection	130 cm
		
7527-N70	Suction valve tube with Nylon LL-M and biopsy channel tube with Nylon LL-M	130 cm 130 cm
		

Options:

Log printer

Order no.	Description
7210 – D20	Log printer

Appendix III: Replacement parts for SCOPE-CLEANER SC10 flushing pump

Order no.	Description
7000-102	Housing without the front and rear panels
7000-205	Front panel for SC-10
7000-305	Rear panel for SC
7001-452	CPC plugs, acetal Schott-type with tube fitting
7001-600	LL-W metal (stainless steel) built-in
7001-620	LL plate ring, red
7001-621	LL plate ring, blue
7001-622	LL plate ring, green
7001-623	LL plate ring, white
7002-400	Oscillating armature pumps, model 117, 230 V, 50 Hz
7002-130	Anti-vibration mounting 15 x 15 mm
7003-001N	PCB for SC-10
7003-100	Pressure monitor 0.8 bar for SC-10
5220-730	2-pin mains plug with fuse insert (<i>without fuses</i>)
7003-910	Fine fuse 5/20 T 0.25 A
7004-400	T-piece 4-4-4 mm
7004-410	T-piece 4-6-4 mm
7004-420	T-piece 6-4-6 mm
7002-210	Diaphragm pump block for model 113 (replacement)
7002-215	Silicone valve shim for pump type 113
7002-211	Replacement diaphragm for diaphragm pump types 113 and 117

Appendix IV: Recommendations for preventing contamination through infection

Please only use a disinfectant that is included in the list of disinfectants issued by the German Association for Applied Hygiene (VAH), compiled in combination with the trade associations DGHM, DGKH, GHUP, BVÖGD and BDH on the basis of the standard methods developed by the DGHM, for testing chemical disinfection processes and approved as being effective in prophylactic disinfection and hygienic hand-disinfection, or which fully meets all the requirements of the manufacturer of the endoscope.

- Use procedures for prophylactic disinfection and hygienic hand washing that meet the requirements of endoscope manufacturers.
- We recommend using enzymatic cleaners which are effective against amylase and protease to inhibit and destroy biofilm.
- We recommend you run the self-disinfecting function if the device has not been used for longer than 24 hours. This approach is recommended by a number of manufacturers of endoscopes.
- To provide monitoring of the self-disinfecting function, we have developed a log printer which not only logs the disinfection of endoscopes but also gives your staff a way of checking when the SCOPE-CLEANER SC10 was last used. After the self-disinfecting function has been used, the SCOPE-CLEANER SC10 provides you with a printed log for you to file.
- Please remember to have your mains water supply (drinking water quality) checked for contamination at regular intervals.
- The strainers (replacement metal strainer spare part no. 7500-220) in the suction filters should be visually checked every day and replaced if soiled, at the latest every fortnight.
- Diaphragms and internal tubing should be replaced at the latest once a year during scheduled servicing. If contamination is detected, these parts must be replaced immediately. The replacement parts can be found in the replacement parts list.

Reporting

All incidents and near incidents occurring in connection with this product under the German Medical Devices Safety Plan Ordinance (MPSV) are to be reported to the manufacturer and the competent authority of the Member State in which the user and/or patient is established.

For the Federal Republic of Germany, this is:

Federal Institute for Drugs and Medical Devices (BfArM)

Kurt-Georg-Kiesinger-Allee 3,

53175 Bonn, Germany

www.bfarm.de

Certificates

Certificates and Declaration of Conformity are available on request.

In the event that these documents are mislaid or if you need additional copies, please contact:



CREO MEDICAL GmbH

Hans-Böckler-Straße 29
40764 Langenfeld – Germany

Tel. +49 (0) 2173 20047-0
Fax. +49 (0) 2173 20047-40
E-Mail info.de@creomedical.de
Web www.creomedical.com